

Häcker
kitchen.germanMade.

Systemat and SystematART



Training content

1. Systemat in general
2. Systemat
3. SystematART
4. OneLine
5. Open Discussion & Questions



1. Systemat in general

Häcker
kitchen.germanMade.



Version 11/2022

Two product lines for every taste

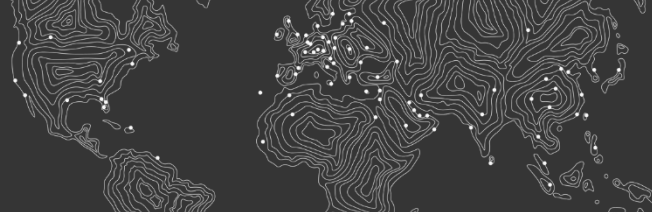

systemat
Our product line with handles



systematART
Our handleless product line

Key messages:

- 1) Design box – 3 design box colors
- 2) Visible side concept
- 3) Lacquer expertise – 190 RAL and 1950 NCS colors available
- 4) Technique – Metro Box as standard and innovative SLD drawer

Box



2077 crystal white
KA/KI/KK



2022 light grey
KA/KI/KK



2059 titanium
KA/KI/KK

KK = box edge
KI = box inside
KA = box outside

- Material thickness
 - 16mm (5/8") for sides
 - 19mm (3/4") for shelves

Visible box sides

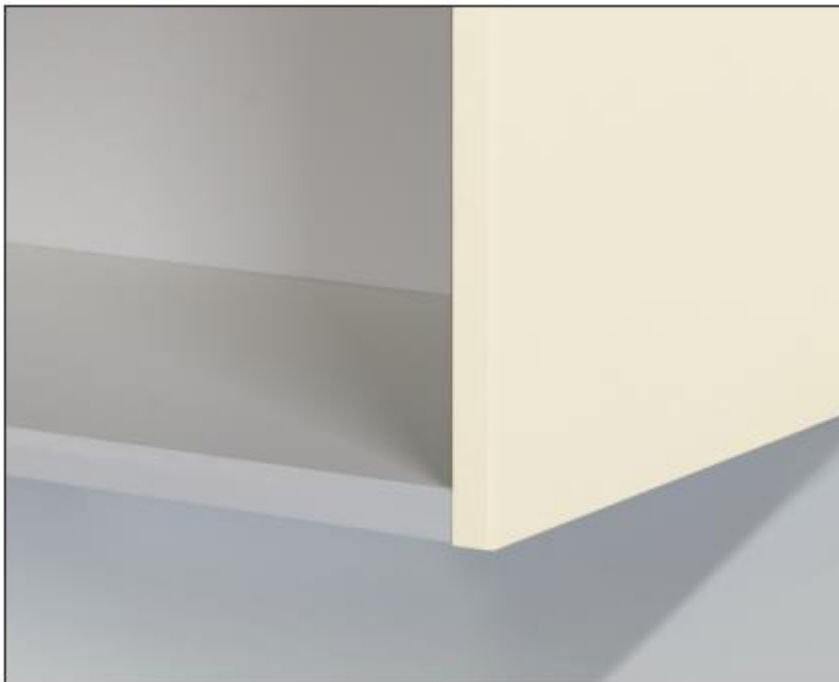

Visible sides

visible sides choice in

lacquer:	6055
lacquer PerfectSense®	2130/2135
satin lacquer:	5035/5045/6000
veneered:	6023/6080/6082
high gloss lacquer:	4030

- Instead of box sides, visible box sides can be adapted in the front color.
- The visible box side front edge is the same color as the visible side.
- Please note: Visible box sides are not available for cabinets in 24" box depth.

RAL & NCS Colors

Program

AV6000/ AV6055/ AV5035/ AV5045
+ available surroundings

Colors

RAL Classic swatch book
(190 colors, except pearl- and luminous paint)
1950 NCS colors

Surcharge

Surcharge per color starting from one piece/front - MP-RAL/NCS \$679.70 (net price)

Order head data

Definition of the program „RAL“ or “NCS” in the relevant front range

Color combinations



Per article only one RAL/NCS code is possible

Longer lead time

15 days

Special lacquering according to the RAL/NCS-colour system - Please specify range and RAL/NCS-no.

AV 6000 PG 3	AV 5035 PG 4	AV 5045 PG 4	AV 6055 PG 5
--------------	--------------	--------------	--------------

			
RAL (A 972 / V 972) NCS (A 934 / V 934)	RAL (A 974) NCS (A 936)	RAL (A 979 / V 979) NCS (A 946 / V 946)	RAL (A 978 / V 978) NCS (A 944 / V 944)



Technique

Metro

- 16mm (5/8“) drawer boxes
- Maximum load capacity:
 - Drawers: 40 KG / 88, 18 lb
 - Pull-outs 30-60cm wide: 40 KG / 88,18 lb
 - Pull-outs 80-120cm wide: 70 KG / 154,32 lb

drawer Metro



drawer without surcharge

Metro box R (72)



pull-out without surcharge

Metro Glas R, 0.31" thick (73)
with Häcker Kitchens brand label (76)



Surcharge for pull-out Metro Glas
MP-GLAS 34.90 \$ per pull-out

Metro Glas R LED, 0.31" thick (74)
with Häcker Kitchen brand label (75)



Surcharge for pull-out Metro Glas R LED
MP-AZLED 245.50 \$ per pull-out

The glass sides are provided with LED-lighting.
There is no need to order the surcharge ME-GLAS additionally.
Delivery without batteries.

Technique

SLD – Slim Line Drawer

- 8mm (5/16“) drawer boxes
- Maximum load capacity:
 - Drawers: 40 KG / 88, 18 lb
 - Pull-outs 30-60cm wide: 40 KG / 88,18 lb
 - Pull-outs 80-120cm wide: 70 KG / 154,32 lb



drawer SLD



Surcharge for drawer **SLD** compared to Metro
MP-SSK 44.4 \$ pro drawer

SLD box (82)



Surcharge for pull-out **SLD** opposite Metro box
MP-SBOX 44.4 \$ per pull-out

SLD Glas 0.31" thick (83)
with Häcker Kitchens brand label (86)



Surcharge for pull-out **SLD Glas** opposite Metro box
MP-SAZGLAS 79.20 \$ per pull-out

SLD Glas LED, 8 mm thick (87)

NEW



Surcharge for pull-out **SLD Glas LED**
MP-SAZGLASLED 289.80 \$ per pull-out

Not available for internal pull-outs
The glass sides are provided with LED-lighting.
There is no need to order the surcharge ME-GLAS additionally.
Delivery without batteries.

Technique

- Finish interior equipment: titanium
- Corner base cabinet with swivel shelves LeMans
- Base cabinet with cooking AGENT and soft-closing system
- Base cabinet with internal drawer and removable bottle basket
- Tall pantry cabinet with tandem swivel pull-out
- And more....

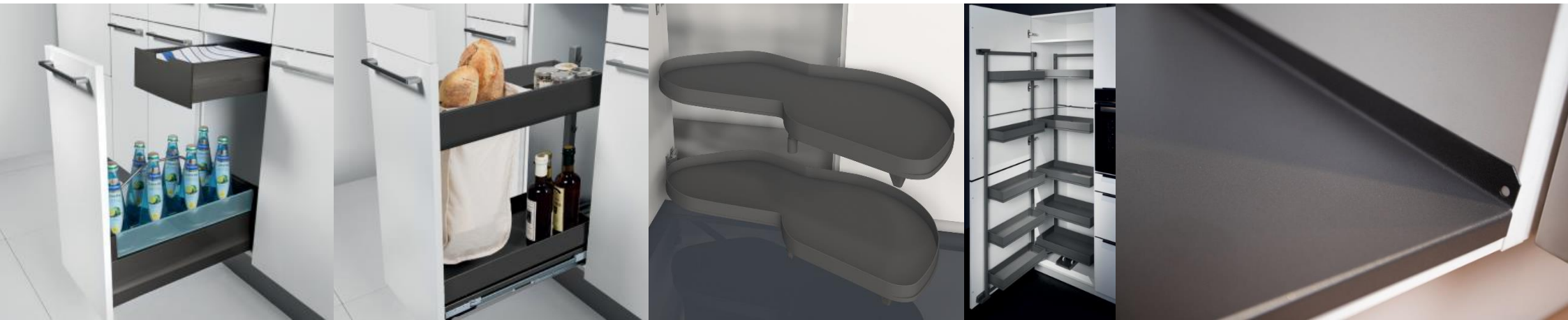

Quality

- Hinges with integrated damping
 - Quick installation, no tools required
- All hinges are supplied with soft closing
 - Soft closing from a closing angle of 35°
 - Opening angle 110°
- Shelves are always 19mm (3/4") thick
 - Metal shelf supports come with safety pin (only towards the front)
- Full metal hanging rail
- 3-way adjustment from the interior
- Safe and robust (50kg/m² / 110.23lb/10.76sqft bearing area (shelves))



2. Systemat

Häcker
kitchen.germanMade.



Version 11/2022

- systemat standard base cabinet height 78 cm (30.71")
- 13cm (5") grid (front 126mm + 4mm front gap = 130mm)

Base cabinets:
78 cm = 30.71"





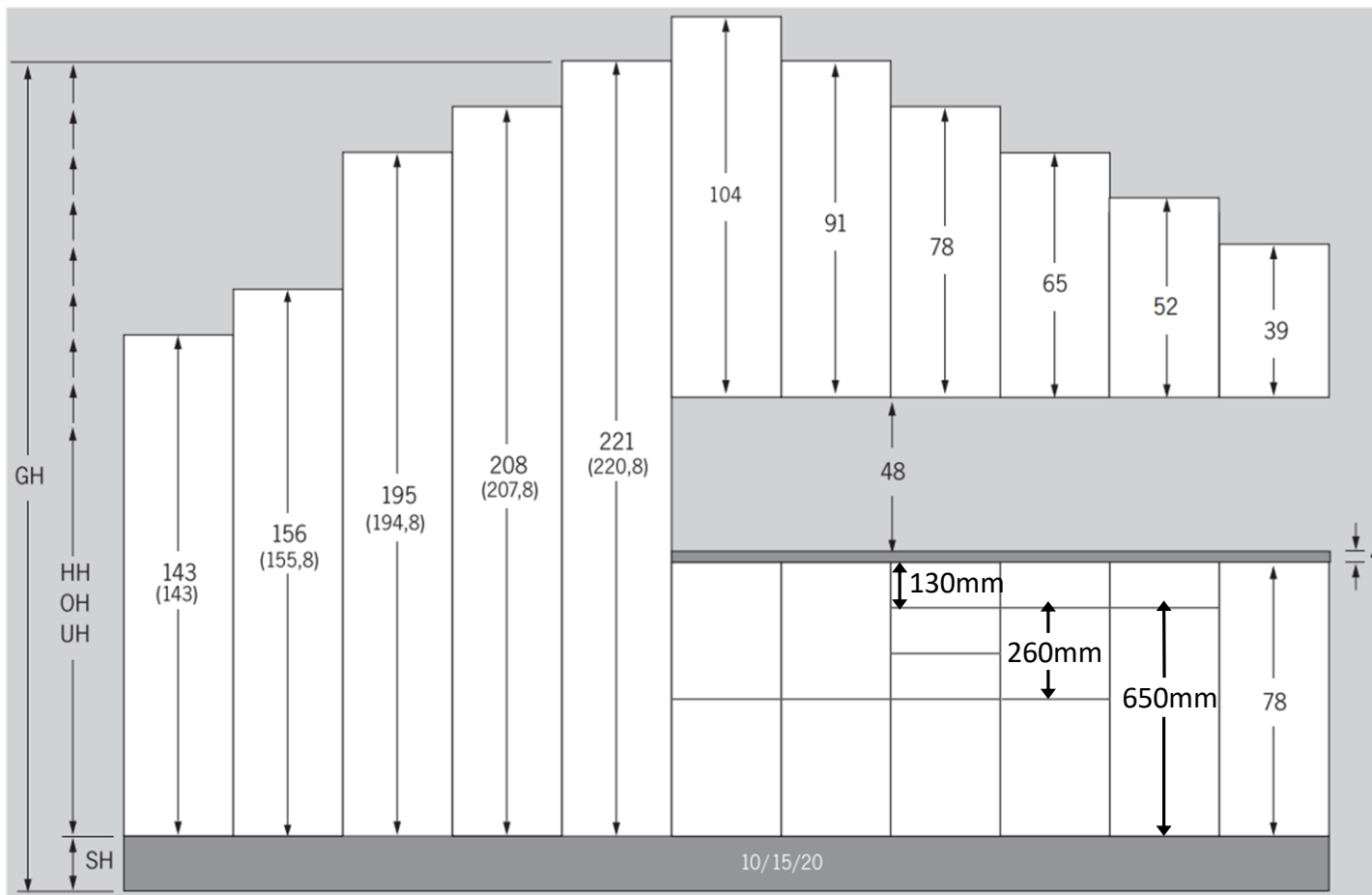





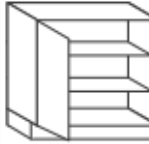

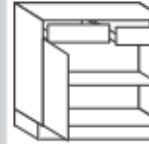

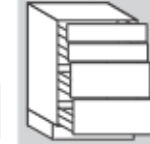
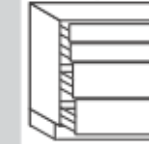

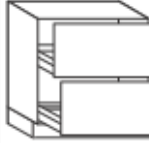
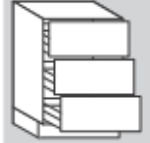
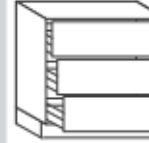
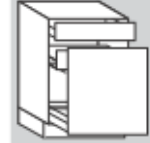

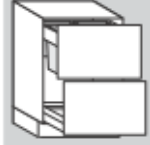
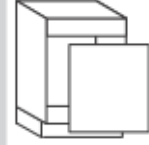

Tall cabinets:
143 cm = 56.3"
156 cm = 61.42"
195 cm = 76.77"
208 cm = 81.89"
221 cm = 87"

Wall cabinets:
39 cm = 15.35"
52 cm = 20.47"
65 cm = 25.59"
78 cm = 30.71"
91 cm = 35.83"
104cm = 40.95"

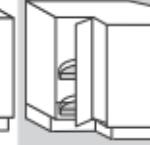
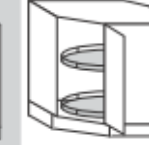

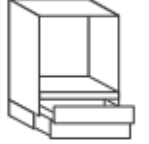
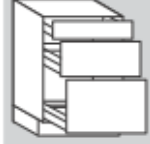
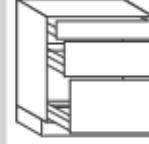
GH = Total height incl. plinth height
HH = Tall unit height
OH = Wall unit height
UH = Base unit height
SH = Plinth height

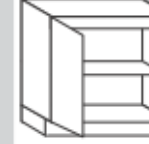
Article overview base cabinets Systemat

<p>shelves</p>  <p>U3078D U4078D U4578D U5078D U6078D</p>	<p>shelves</p>  <p>U8078D U9078D U10078D</p>	<p>drawer</p>  <p>US3078 US4078 US4578 US5078 US6078</p>	<p>drawers</p>  <p>US8078 US9078 US10078</p>	<p>drawer pull-outs</p>  <p>US2A3078 US2A4078 US2A4578 US2A5078 US2A6078</p>	<p>drawer pull-outs</p>  <p>US2A8078D US2A9078D US2A10078D US2A12078D</p>	<p>drawers pull-outs</p>  <p>U2S2A3078 U2S2A4078 U2S2A4578 U2S2A5078 U2S2A6078</p>	<p>drawers pull-outs</p>  <p>U2S2A8078D U2S2A9078D U2S2A10078D U2S2A12078D</p>
<p>pull-outs</p>  <p>U2A3078 U2A4078 U2A4578 U2A5078 U2A6078</p>	<p>pull-outs</p>  <p>U2A8078D U2A9078D U2A10078D U2A12078D</p>	<p>pull-outs</p>  <p>U3A3078 U3A4078 U3A4578 U3A5078 U3A6078</p>	<p>pull-outs</p>  <p>U3A8078D U3A9078D U3A10078D U3A12078D</p>	<p>drawer pull-outs</p>  <p>USAIA4078 USAIA4578 USAIA5078 USAIA6078</p>	<p>internal pull-outs</p>  <p>U3IA4578D U3IA5078D U3IA6078D</p>	<p>tea towel holder</p>  <p>UH1578 UH3078D</p>	<p>pull-out for provisions</p>  <p>UA1578 UA3078D</p>
<p>bottle rack</p>  <p>USAIS3078</p>	<p>pull-out table</p>  <p>UST2A6078</p>	<p>waste system</p>  <p>UM2A3078 UM2A4078 UM2A4578 UM2A5078 UM2A6078</p>	<p>for waste system</p>  <p>UM4578 UM5078 UM6078</p>	<p>corner base unit</p>  <p>UESHB11078 UESHB11578 UESHB12578</p>	<p>LeMans</p>  <p>UESLM11078 UESLM11578 UESLM12578</p>	<p>corner base unit</p>  <p>UEHB8078 UEHB9078</p>	<p>corner base unit</p>  <p>UEDHB9078D</p>
<p>oven unit</p>  <p>HUS6078</p>	<p>oven unit</p>  <p>HUGS6078</p>	<p>base units f. built-in hob</p>  <p>UKS2A6078</p>	<p>base units f. built-in hob</p>  <p>UKS2A8078D UKS2A9078D UKS2A10078D UKS2A12078D</p>	<p>base units f. built-in hob</p>  <p>UK40781D UK45781D UK50781D UK60781D</p>	<p>base units f. built-in hob</p>  <p>UK90781D</p>	<p>sink base unit</p>  <p>SPUM4078D SPUM4578D SPUM5078D SPUM6078D</p>	<p>sink base unit</p>  <p>SPUM8078D SPUM9078D SPUM10078D SPUM12078D</p>

cm	Order number	Code	Price groups									
			0	1	2	3	4	5	6	7	8	9
30	US2A3078	U30.78.28	468	484	499	522	542	561	580	603	857	940
40	US2A4078	U40.78.28	481	497	514	543	569	590	611	636	895	1056
45	US2A4578	U45.78.28	487	503	522	554	582	606	630	658	924	1120
50	US2A5078	U50.78.28	494	510	532	565	594	620	646	680	954	1190
60	US2A6078	U60.78.28	510	526	550	592	624	652	684	724	991	1318
80	US2A8078D	U80.78.28	676	700	736	800	831	864	896	942	1384	1632
90	US2A9078D	U90.78.28	694	718	757	828	861	901	942	994	1464	1770
100	US2A10078D	U100.78.28	718	742	786	866	901	944	999	1054	1552	1916
120	US2A12078D	U120.78.28	750	774	824	918	960	-	1094	1160	1706	2170

US2A6078

U = base cabinet

S = drawer

2 A = 2 pull-outs

60 = cabinet width

78 = box height

(German = **U**nterschrank)

(German = **S**chubkasten)

(German = **2 A**uszüge)

→ in systemat the **box height** is part of the order number!

3. SystematART

Häcker
kitchen.germanMade.



Version 11/2022

- systematART standard base cabinet height 78 cm (30.71")

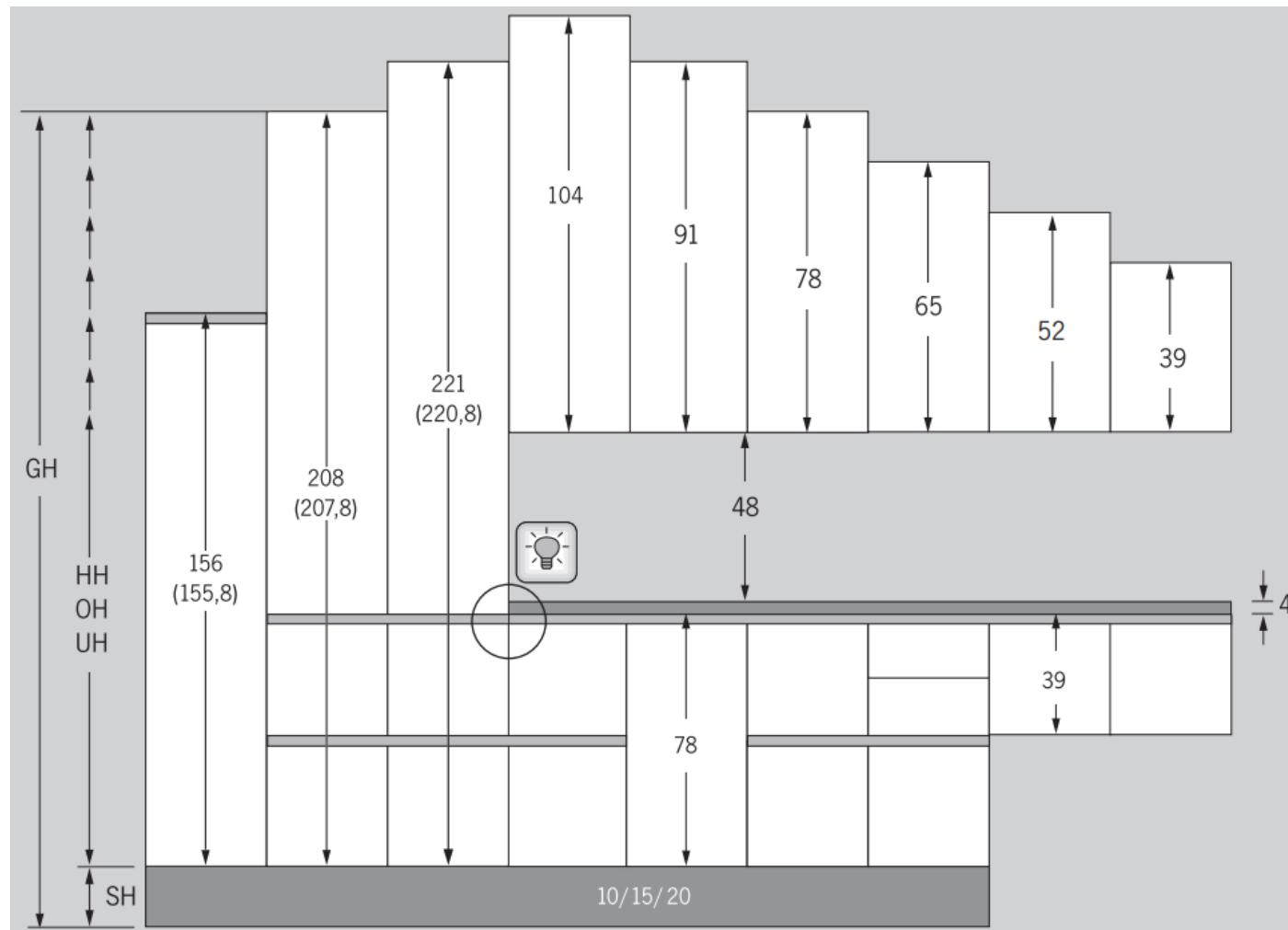

Base cabinets:
78 cm = 30.71"
39 cm = 15.35"

Tall (horizontal):
156 cm = 61.42"
208 cm = 81.89"
221 cm = 87"

Wall cabinets:
39 cm = 15.35"
52 cm = 20.47"
65 cm = 25.59"
78 cm = 30.71"
91 cm = 35.83"
104cm = 40.95"



- If the base cabinets are planned next to the tall cabinets, small seam will be visible at the transition of the L-profile of the base cabinets to the C-profile of the tall cabinets
 - side panel needs to be planned next to the base units if this is not desired.

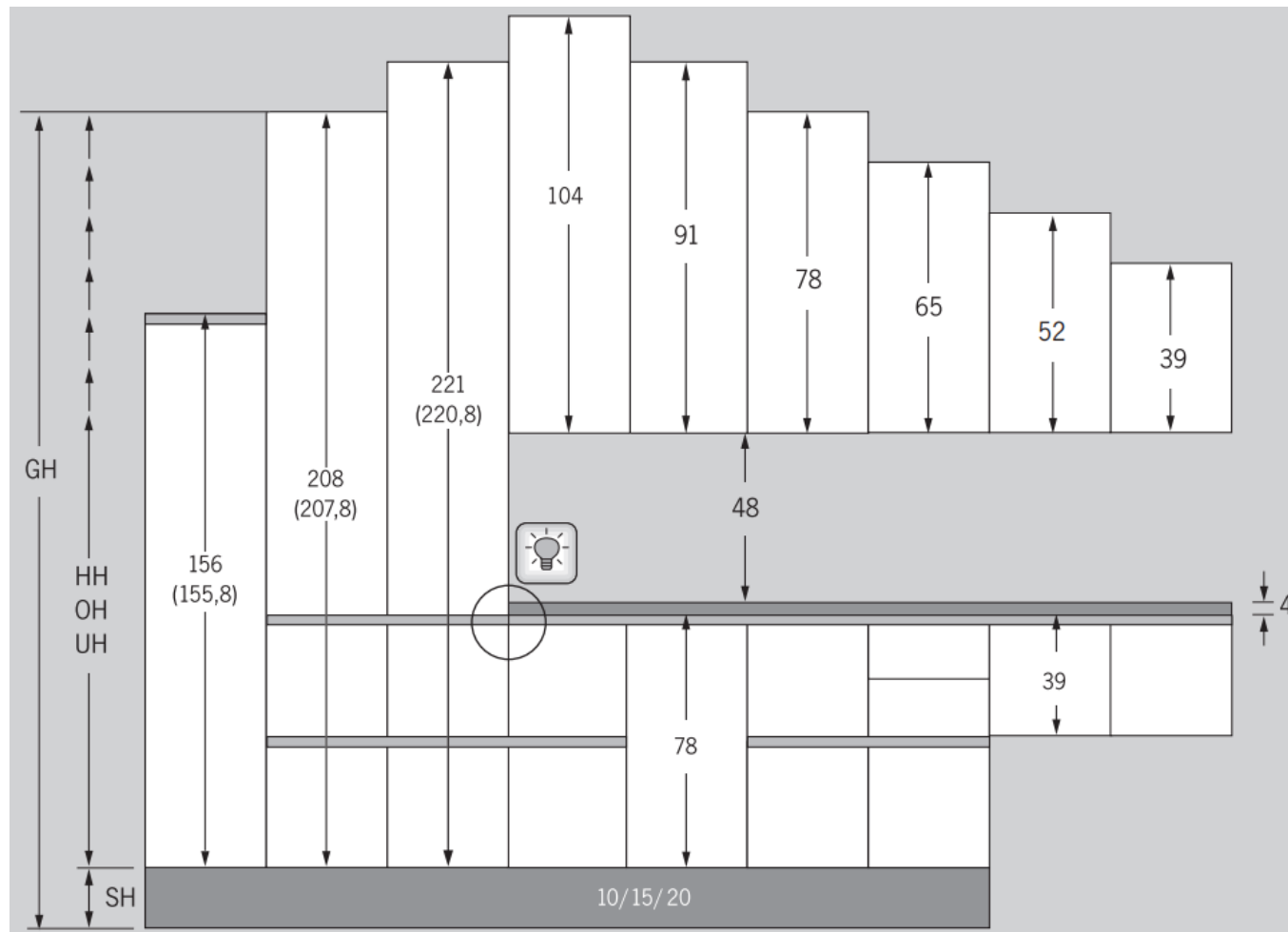









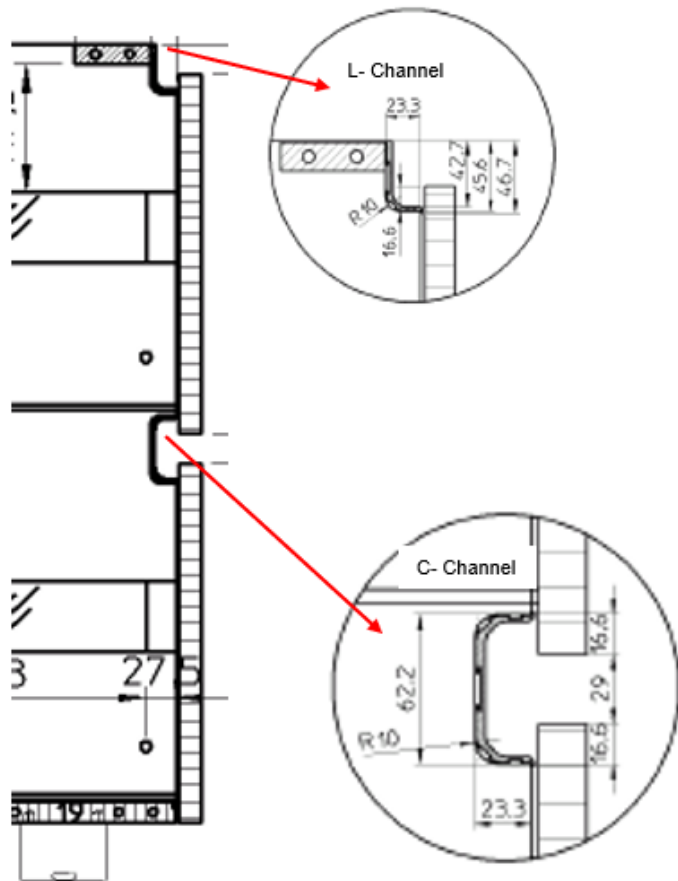







- Handle is replaced by a **channel handle**
- Channel handle is located in the box
- Cabinet can be opened by grabbing the upper end of the door or drawer panel



- Base cabinets with horizontal channel handle available in 14 different finishes



finishes:

				
377 crystal white matt	352 polar white matt	305 white matt	363 taupe matt	322 light grey matt
				
378 pearl grey matt	376 graphite matt	355 black matt	364 gold colour brushed	320 stainl. steel col. brushed
				
321 eucalyptus matt	306 natural umber matt			
				
319 crema-magnolia matt	340 cashmere matt			

- Tall cabinets with horizontal or vertical channel handle available in 14 different finishes

vertical



horizontal

finishes:



377
crystal white matt



352
polar white matt



305
white matt



363
taupe matt



322
light grey matt



378
pearl grey matt

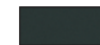

376
graphite matt



355
black matt



364
gold colour
brushed



320
stainl. steel col.
brushed

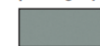

321
eucalyptus matt

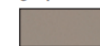

306
natural umber matt



319
crema-magnolia
matt



340
cashmere matt

- Different vertical channel handles

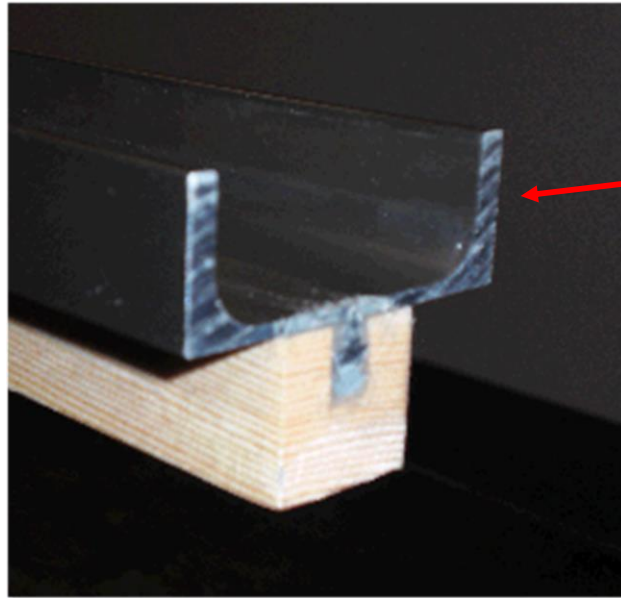

C-Channel
handle (DK)

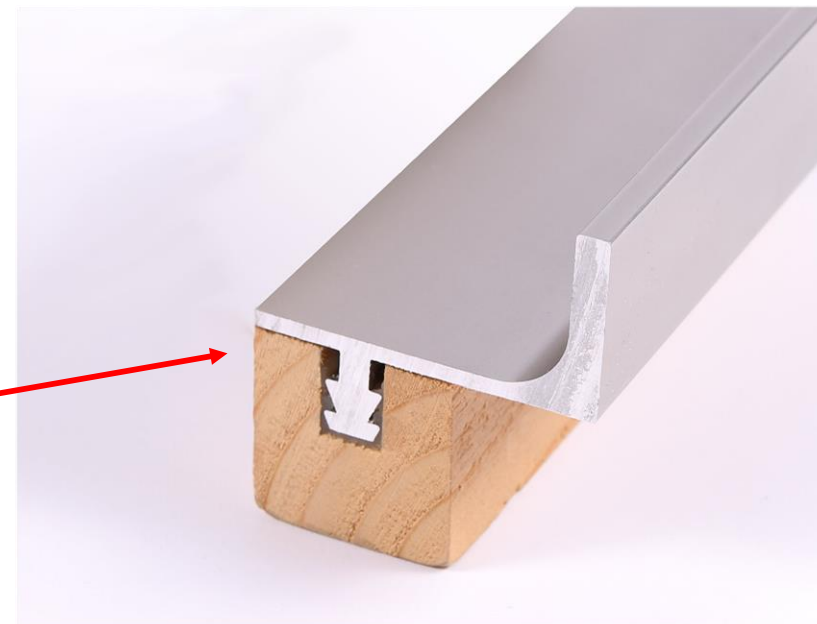







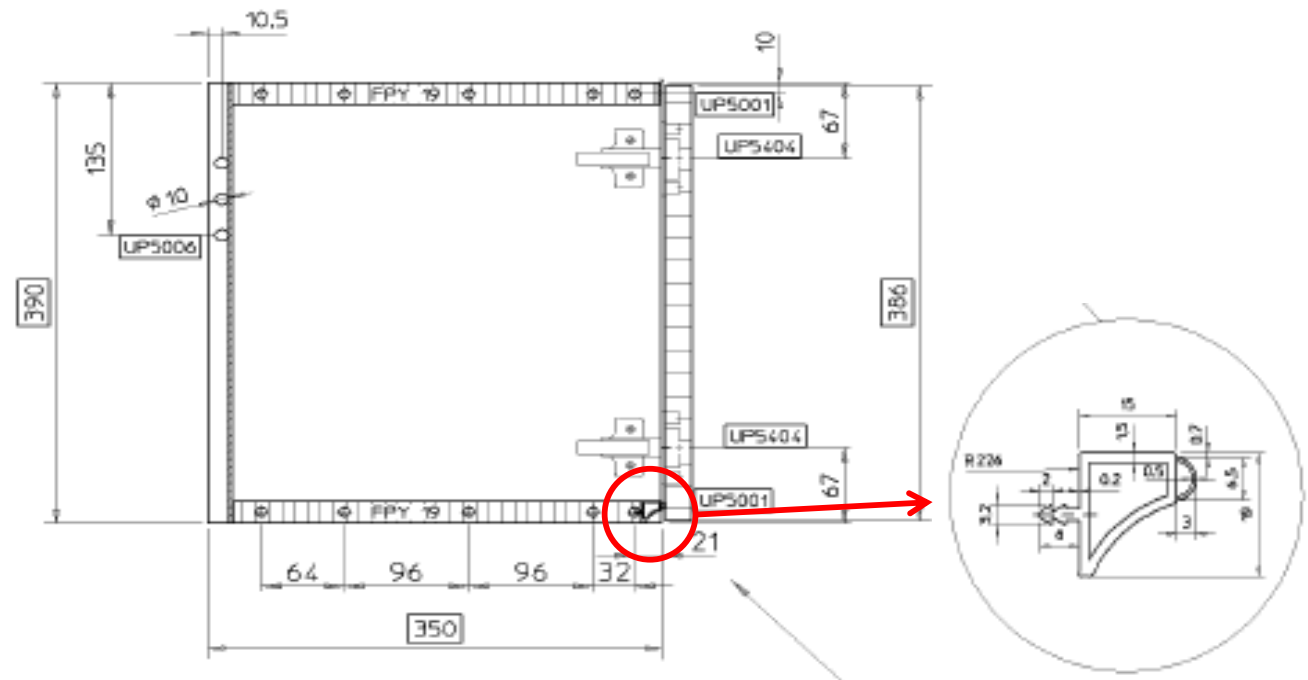

L-Channel
handle (DKS)

- Wall cabinets have a bottom shelf with an integrated profile

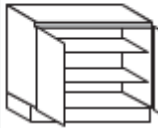
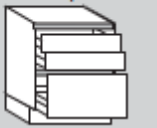
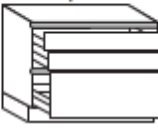
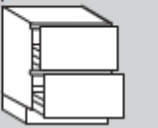
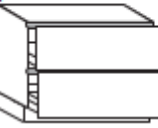
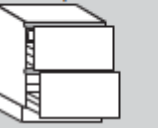
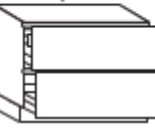
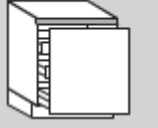
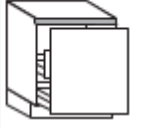

stainless steel colored

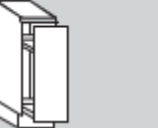
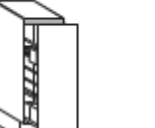
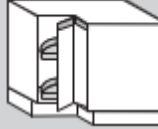
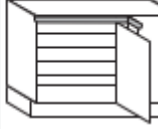
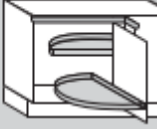

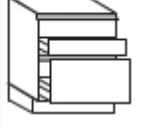
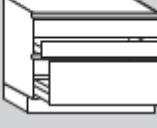
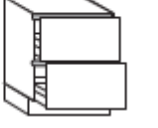
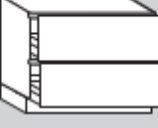
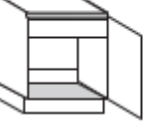
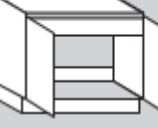
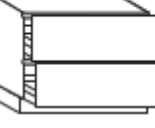
<p>shelves</p>  <p>VU3078D VU4078D VU4578D VU5078D VU6078D</p>	<p>shelves</p>  <p>VU8078D VU9078D VU10078D VU12078D</p>	<p>drawers pull-out</p>  <p>VU2SA3078 VU2SA4078 VU2SA4578 VU2SA5078 VU2SA6078</p>	<p>drawers pull-out</p>  <p>VU2SA8078D VU2SA9078D VU2SA10078D VU2SA12078D</p>	<p>pull-outs</p>  <p>VU2A3078 VU2A4078 VU2A4578 VU2A5078 VU2A6078</p>	<p>pull-outs</p>  <p>VU2A8078D VU2A9078D VU2A10078D VU2A12078D</p>	<p>drawers pull-out</p>  <p>VU2AIS3078 VU2AIS4078 VU2AIS4578 VU2AIS5078 VU2AIS6078</p>	<p>drawers pull-out</p>  <p>VU2AIS8078D VU2AIS9078D VU2AIS10078D VU2AIS12078D</p>
<p>drawers pull-out</p>  <p>VUA2IS3078D VUA2IS4078D VUA2IS4578D VUA2IS5078D VUA2IS6078D</p>	<p>pull-outs</p>  <p>VUAIA4078D VUAIA4578D VUAIA5078D VUAIA6078D</p>	<p>internal pull-outs</p>  <p>VU2IA4578D VU2IA5078D VU2IA6078D</p>	<p>internal pull-outs</p>  <p>VUIS2IA4578D VUIS2IA5078D VUIS2IA6078D</p>	<p>tea towel holder</p>  <p>VUH3078D</p>	<p>pull-out for provisions</p>  <p>VUAIS3078D</p>	<p>pull-out for provisions</p>  <p>VUA3078D</p>	<p>cooking AGENT</p>  <p>VUACA3078D</p>
<p>corner base unit</p>  <p>VUEHB8078 VUEHB9078</p>	<p>corner base unit</p>  <p>VUE10578D VUE11078D VUE11578D VUE12578D</p>	<p>swivel shelves</p>  <p>VUEHB11078D VUEHB11578D VUEHB12578D</p>	<p>LeMans</p>  <p>VUELM11078D VUELM11578D VUELM12578D</p>				
<p>oven unit</p>  <p>VHU6078</p>	<p>base units f. built-in hob</p>  <p>VUKSA6078</p>	<p>base units f. built-in hob</p>  <p>VUKSA8078D VUKSA9078D VUKSA10078D VUKSA12078D</p>	<p>base units f. built-in hob</p>  <p>VUK2A6078</p>	<p>base units f. built-in hob</p>  <p>VUK2A8078D VUK2A9078D VUK2A10078D VUK2A12078D</p>	<p>sink base unit</p>  <p>VSPUM4078D VSPUM4578D VSPUM5078D VSPUM6078D</p>	<p>sink base unit</p>  <p>VSPUM8078D VSPUM9078D VSPUM10078D</p>	<p>sink base unit</p>  <p>VSPU2A6078 VSPU2A8078D VSPU2A9078D VSPU2A10078D VSPU2A12078D</p>



cm	Order number	Code	Price groups GL									
			0	1	2	3	4	5	6	7	8	9
30	VU2SA3078	VU30.78.63	520	536	555	585	-	-	627	647	848	921
40	VU2SA4078	VU40.78.63	544	560	581	615	-	-	666	692	912	1053
45	VU2SA4578	VU45.78.63	558	575	596	632	-	-	693	722	955	1126
50	VU2SA5078	VU50.78.63	570	587	611	647	-	-	719	749	995	1194
60	VU2SA6078	VU60.78.63	598	617	644	690	-	-	780	814	1084	1362
80	VU2SA8078D	VU80.78.63	751	778	810	870	-	-	963	1005	1406	1710
90	VU2SA9078D	VU90.78.63	781	808	842	910	-	-	1015	1058	1476	1830
100	VU2SA10078D	VU100.78.63	816	844	883	956	-	-	1080	1128	1566	1982
120	VU2SA12078D	VU120.78.63	874	904	946	1032	-	-	1162	1224	1720	2282

VU2SA6078

- V** = handle less
- U** = base cabinet (German = **U**nterschrank)
- 2S** = drawers (German = 2 **S**chubkästen)
- A** = pull-out (German = **A**uszug)
- 60** = cabinet width
- 78** = box height

→ For handleless cabinets in systemat add **V**.

4. oneLine

Häcker
kitchen.germanMade.



Version 11/2022

In addition to systematART, we also offer **oneLine**. The middle C-shaped channel handle is removed.

All drawers and pull-outs that cannot be opened by the L-bar, are automatically equipped with Tipmatic Softclose. The system is already included in the cabinet price.



The front height of the bottom drawer is 386mm (as in Systemat).

The **oneLine** base cabinets can be perfectly combined with ART base cabinets that either have a **hinged door** or a **pull-out** in 751mm front height.

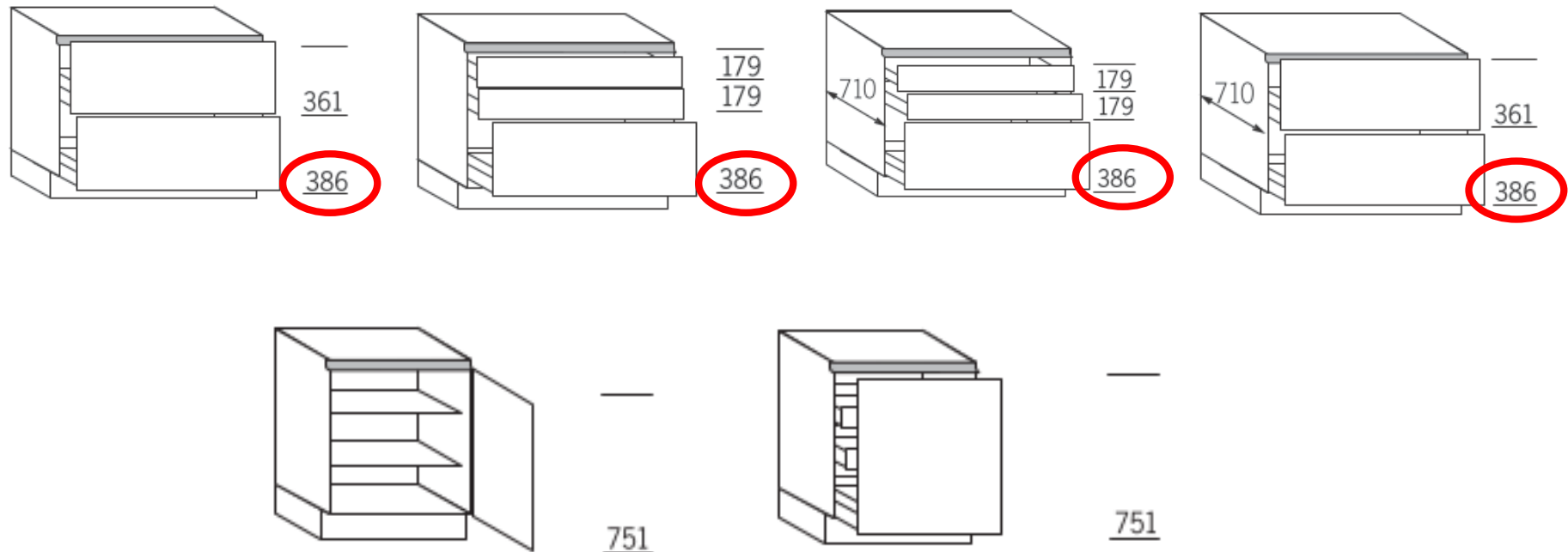



Tipmatic Softclose (MP-TMSC)

- for drawers and pull-outs
- factory-mounted mechanic opening assistance

Release

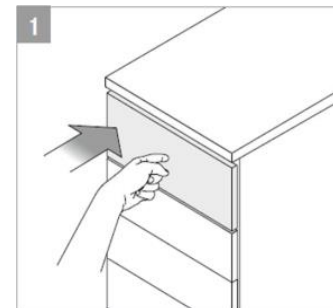

Opening

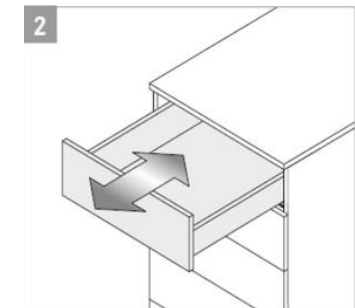

Span

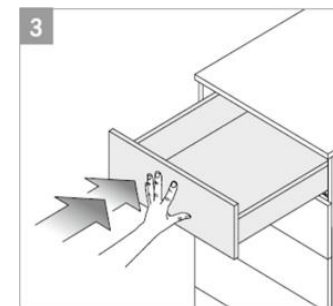



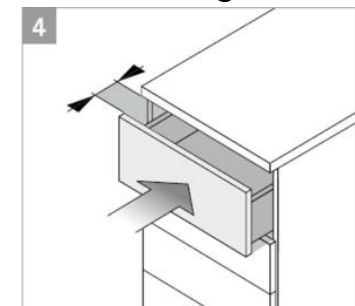







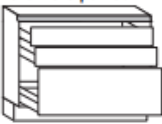

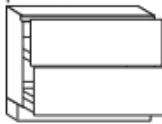

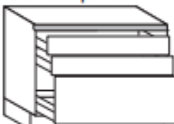
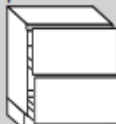
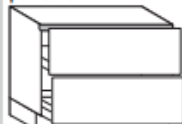

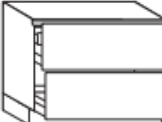
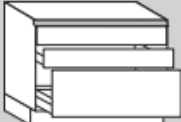
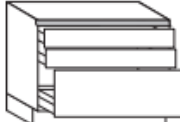
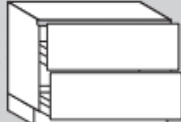
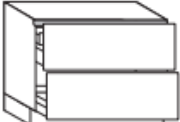
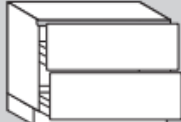
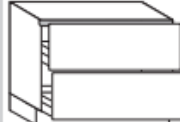

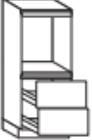



Self-closing









OneLine also available for tall cabinets
with horizontal channel handle

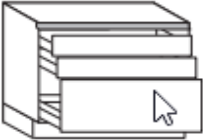

Article overview base cabinets oneLine

<p>drawers pull-out</p>  <p>LU2SA45783 LU2SA50783 LU2SA60783</p>	<p>drawers pull-out</p>  <p>LU2SA80783 LU2SA90783 LU2SA100783 LU2SA120783</p>	<p>pull-outs</p>  <p>LU2A45783 LU2A50783 LU2A60783</p>	<p>pull-outs</p>  <p>LU2A80783 LU2A90783 LU2A100783 LU2A120783</p>	<p>drawers pull-out</p>  <p>LU2SA3078 LU2SA4078 LU2SA4578 LU2SA5078 LU2SA6078</p>	<p>drawers pull-out</p>  <p>LU2SA8078D LU2SA9078D LU2SA10078D LU2SA12078D</p>	<p>pull-outs</p>  <p>LU2A3078 LU2A4078 LU2A4578 LU2A5078 LU2A6078</p>	<p>pull-outs</p>  <p>LU2A8078D LU2A9078D LU2A10078D LU2A12078D</p>
<p>drawer pull-outs</p>  <p>LU2AIS3078 LU2AIS4078 LU2AIS4578 LU2AIS5078 LU2AIS6078</p>	<p>drawer pull-outs</p>  <p>LU2AIS8078D LU2AIS9078D LU2AIS10078D LU2AIS12078D</p>	<p>Base units for built-in hob</p>  <p>LUKSA6078 LUKSA8078D LUKSA9078D LUKSA10078D LUKSA12078D</p>	<p>Base units for built-in hob</p>  <p>LUK2SA6078 LUK2SA8078D LUK2SA9078D LUK2SA10078D LUK2SA12078D</p>	<p>Base units for built-in hob</p>  <p>LUK2A6078 LUK2A8078D LUK2A9078D LUK2A10078D LUK2A12078D</p>	<p>Base units for built-in hob</p>  <p>LUK2AIS6078 LUK2AIS8078D LUK2AIS9078D LUK2AIS10078D LUK2AIS12078D</p>	<p>Sink base unit</p>  <p>LSPU2A6078 LSPU2A8078D LSPU2A9078D LSPU2A10078D LSPU2A12078D</p>	<p>Sink base unit</p>  <p>LSPUAMA6078 LSPUAMA8078D LSPUAMA9078D LSPUAMA10078D LSPUAMA12078D</p>
<p>Tall unit for appliances</p>  <p>LG45S2A156</p> <p>aperture: 17.72"</p>	<p>Tall unit for appliances</p>  <p>LG592A156</p> <p>aperture: 23.43"</p>	<p>Tall unit for appliances</p>  <p>LG5938A156</p> <p>aperture: 15.16" aperture: 23.43"</p>	<p>Tall unit for appliances</p>  <p>LG88A156</p> <p>aperture: 34.57"</p>	<p>Tall unit for appliances</p>  <p>LG103A156</p> <p>aperture: 40.55"</p>	<p>Tall unit for appliances</p>  <p>LG45S2A208</p> <p>aperture: 17.72"</p>	<p>Tall unit for appliances</p>  <p>LG592A208</p> <p>aperture: 23.43"</p>	<p>Tall unit for appliances</p>  <p>LG5938A208</p> <p>aperture: 14.96" aperture: 23.43"</p>
<p>Tall unit for appliances</p>  <p>LG882A208</p> <p>aperture: 34.57"</p>	<p>Tall unit for appliances</p>  <p>LG1032A208</p> <p>aperture: 40.55"</p>	<p>Tall unit for appliances</p>  <p>LG1232A208</p> <p>aperture: 48.23"</p>	<p>Tall unit for appliances</p>  <p>LG45S2A221</p> <p>aperture: 17.72"</p>	<p>Tall unit for appliances</p>  <p>LG592A221</p> <p>aperture: 23.43"</p>	<p>Tall unit for appliances</p>  <p>LG882A221</p> <p>aperture: 34.57"</p>	<p>Tall unit for appliances</p>  <p>LG103A221</p> <p>aperture: 40.55"</p>	<p>Tall unit for appliances</p>  <p>LG1232A221</p> <p>aperture: 48.23"</p>

						Price groups GL									
						0	1	2	3	4	5	6	7	8	9
 <p>179 179 386</p> <p>Base unit carcase depth 22.05" 1 drawer 1 drawer with Tipmatic Softclose 1 pull-out with Tipmatic Softclose</p>	    AV 6055 GL			Order number	Code										
			11.81	LU2SA3078	LU30.78.63	816	834	860	896	-	938	974	1010	1046	1213
			15.75	LU2SA4078	LU40.78.63	847	866	893	935	-	988	1024	1061	1100	1281
			17.72	LU2SA4578	LU45.78.63	865	883	912	960	-	1024	1060	1100	1140	1334
			19.69	LU2SA5078	LU50.78.63	881	902	931	983	-	1059	1096	1137	1180	1388
			23.62	LU2SA6078	LU60.78.63	912	934	974	1039	-	1121	1174	1219	1275	1534
			31.50	LU2SA8078D	LU80.78.63	1101	1127	1181	1273	-	1348	1406	1463	1521	1920
			35.43	LU2SA9078D	LU90.78.63	1139	1166	1228	1321	-	1417	1476	1534	1595	2003
39.37	LU2SA10078D	LU100.78.63	1177	1209	1272	1368	-	1489	1549	1612	1679	2112			
47.24	LU2SA12078D	LU120.78.63	1254	1286	1362	1489	-	-	1684	1755	1828	2325			

LU2SA6078

- L** = oneLine
- U** = base cabinet (German = **U**nterschrank)
- 2S** = drawers (German = 2 **S**chubkästen)
- A** = pull-out (German = **A**uszug)
- 60** = cabinet width
- 78** = box height

Open discussion & questions



Thank you for your attention

