

Häcker
kitchen.germanMade.

Molding & Panels



Training content

1. Molding
2. Fillers
3. Panels
4. Open Discussion & Questions



Molding

Häcker
kitchen.germanMade.



Version 10/2022

Toe-Kick (SO1)

- Synthetic toe-kick feet, height can be adjusted +/-2cm (3/4")
- All toe-kick panels are equipped with a sealing profile on the bottom
- Secured with a clip to hold panel in place
- Removable and easy to install
- Panel flush with front available (SF10, not free of charge)
- Price determined per 10cm/3.94"

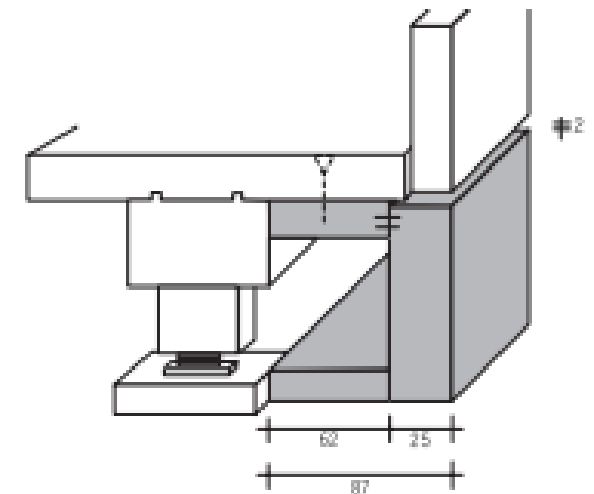

Toe-Kick (SO1)

Available in:

- Shiny + matt laminate (KG, KU)
(free of charge up to a height of 20cm/7.87“)
- High pressure laminate (PU,ED)
- High gloss lacquer (LD)
- Matt lacquer (LM, LMD)
- Ash effect lacquer (LA)
- Veneer (FU, FB)
- Metal

Toe-Kick (SO1)

Available in:

laminare (KU)

(max. length 520 cm)
 224 black
 239 black steel
 340 cashmere
 228 cognac vintage oak effect
 219 crema-magnolia
 077 crystal white
 331 dark pine effect
 376 graphite
 337 grey pine effect
 022 light grey
 325 light pine effect
 233 natural vintage oak effect
 243 oxide
 078 pearl grey
 052 polar white
 292 putty concrete black
 381 putty concrete graphite
 314 putty concrete opal grey
 312 putty concrete pearl grey
 008 silk grey oak effect
 024 stainless steel col.
 189 summer oak effect
 176 taupe

058 walnut effect

038 white

shiny laminare (KG)

(max. length 270 cm)

221 black
 345 cashmere
 269 crema-magnolia
 294 crystal white
 206 graphite
 237 light grey
 229 pearl grey
 209 polar white
 359 taupe
 202 white

HPL (ED)

(max. length 360 cm)
 280 mirror optic (max. 260 cm)
 190 stainless steel effect

laminare (PU)

(max. length 400 cm)
 270 stainless steel col.

effect lacquer (LA)

(max. length 260 cm)

962 ash effect according to NCCS-no.
 973 ash effect according to RAL-no.
 071 ash effect agate blue
 079 ash effect black
 083 ash effect cashmere
 225 ash effect crema-magnolia
 048 ash effect crystal white
 607 ash effect eucalyptus
 040 ash effect graphite
 110 ash effect greige
 061 ash effect light grey
 606 ash effect natural umber
 105 ash effect pastel green
 094 ash effect pearl grey
 182 ash effect taupe
 106 ash effect velvet blue
 084 ash effect white

UV satin lacquer (LMD)

PerfectSense®

(max. length 276 cm)

512 black
 588 black fine oak effect
 578 black velvet oak effect
 577 cashmere
 537 crema-magnolia
 507 crystal white
 587 dark walnut effect
 511 graphite
 576 graphite velvet oak effect
 566 greige velvet oak effect
 579 light fine oak effect
 565 light grey
 585 natural fine oak effect
 586 natural walnut effect
 510 pearl grey
 500 polar white
 509 taupe
 508 white

satin lacquer (LM)

(max. length 260 cm)

961 according to NCS-no.
 972 according to RAL-no.
 299 black
 289 cashmere
 236 crema-magnolia
 222 crystal white
 603 eucalyptus
 338 graphite
 504 greige
 548 light grey
 601 natural umber
 285 pearl grey
 288 polar white
 231 taupe
 235 velvet blue
 291 white

UV high gloss lacquer (LD)

PerfectSense®

(max. length 260 cm)
 247 cashmere
 197 crema-magnolia
 183 crystal white
 127 graphite

126 light grey
 200 pearl grey
 179 polar white
 195 taupe
 186 white

veneered embossed (FU)

(max. length 256 cm)
 409 reclaimed wood
 408 smoked oak
 407 volcano oak

veneered brushed (FB)

(max. length 290 cm)
 428 black oak
 433 elegant oak
 434 elegant walnut
 472 larch
 466 mocha vintage oak
 470 natural wild oak
 471 nougat wild oak
 465 sherry vintage oak
 473 walnut

Toe-Kick (SO1)

Water resistant toe-kick panels

- Laminate stainless steel colored (270), polyurethane foam board
- Aluminium stainless steel effect, slats toe-kick panel (SOL1)



Ceiling Filler (DE29)

- Available in same finishes as toe-kick (SO1)
- Flush with box, not with front!
- Price determined per 10cm/3.94“ and height:
 - 6cm – 10cm / 2.36“ – 3.94“
 - 11cm – 15cm / 4.33“ – 5.91“
 - 16cm – 29cm / 6.3“ – 11.42“

laminat (KU)

(max. length 520 cm)
 224 black
 239 black steel
 340 cashmere
 228 cognac vintage oak effect
 219 crema-magnolia
 077 crystal white
 331 dark pine effect
 376 graphite
 337 grey pine effect
 022 light grey
 325 light pine effect
 233 natural vintage oak effect
 243 oxide
 078 pearl grey
 052 polar white
 292 putty concrete black
 381 putty concrete graphite
 314 putty concrete opal grey
 312 putty concrete pearl grey
 008 silk grey oak effect
 024 stainless steel col.
 189 summer oak effect
 176 taupe

058 walnut effect
 038 white
shiny laminat (KG)
 (max. length 270 cm)

221 black
 345 cashmere
 269 crema-magnolia
 294 crystal white
 206 graphite
 237 light grey
 229 pearl grey
 209 polar white
 359 taupe
 202 white

HPL (ED)

(max. length 360 cm)
 280 mirror optic (max. 260 cm)
 190 stainless steel effect

laminat (PU)

(max. length 400 cm)
 270 stainless steel col.

effect lacquer (LA)

(max. length 260 cm)
 962 ash effect according to NCCS-no.
 973 ash effect according to RAL-no.
 071 ash effect agate blue
 079 ash effect black
 083 ash effect cashmere
 225 ash effect crema-magnolia
 048 ash effect crystal white
 607 ash effect eucalyptus
 040 ash effect graphite
 110 ash effect greige
 061 ash effect light grey
 606 ash effect natural umber
 105 ash effect pastel green
 094 ash effect pearl grey
 182 ash effect taupe
 106 ash effect velvet blue
 084 ash effect white

UV satin lacquer (LMD) PerfectSense®

(max. length 276 cm)
 512 black
 588 black fine oak effect
 578 black velvet oak effect
 577 cashmere
 537 crema-magnolia
 507 crystal white
 587 dark walnut effect
 511 graphite
 576 graphite velvet oak effect
 566 greige velvet oak effect
 579 light fine oak effect
 565 light grey
 585 natural fine oak effect
 586 natural walnut effect
 510 pearl grey
 500 polar white
 509 taupe
 508 white

satin lacquer (LM)

(max. length 260 cm)
 961 according to NCS-no.
 972 according to RAL-no.
 299 black
 289 cashmere
 236 crema-magnolia
 222 crystal white
 603 eucalyptus
 338 graphite
 504 greige
 548 light grey
 601 natural umber
 285 pearl grey
 288 polar white
 231 taupe
 235 velvet blue
 291 white

UV high gloss lacquer (LD) PerfectSense®

(max. length 260 cm)
 247 cashmere
 197 crema-magnolia
 183 crystal white
 127 graphite

126 light grey
 200 pearl grey
 179 polar white
 195 taupe
 186 white

veneered embossed (FU)

(max. length 256 cm)
 409 reclaimed wood
 408 smoked oak
 407 volcano oak

veneered brushed (FB)

(max. length 290 cm)
 428 black oak
 433 elegant oak
 434 elegant walnut
 472 larch
 466 mocha vintage oak
 470 natural wild oak
 471 nougat wild oak
 465 sherry vintage oak
 473 walnut

Crown Molding

- Three different kinds of crown molding
- Max length 360cm/142"
- Can be ordered to size or in standard length 360cm/142" to be cut on site
- Height not customizable



KP74, 32mm/1.6"



KP60, 93.5mm/3.7"

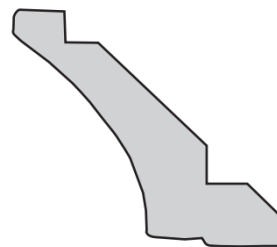

KP64, 90mm/3.5"

effect lacquer (LA)
KP64/LI59

962 ash eff. according to NCS-no.	182 ash effect taupe
973 ash effect according to RAL-no.	106 ash effect velvet blue
071 ash effect agate blue	084 ash effect white
079 ash effect black	
083 ash effect cashmere	
225 ash effect crema-magnolia	
048 ash effect crystal white	
607 ash effect eukalyptus	
040 ash effect graphite	
110 ash effect greige	
061 ash effect light grey	
606 ash effect natural umber	
105 ash effect pastel green	
094 ash effect pearl grey	

satin lacquer (LM)
KP74/LI74

961 according to NCS-no.
972 according to RAL-no.
299 black
289 cashmere
236 crema-magnolia
222 crystal white
603 eucalyptus
338 graphite

504 greige
548 light grey
601 natural umber
285 pearl grey
288 polar white
231 taupe
235 velvet blue
291 white

satin lacquer (LM)
KP64/LI41

961 according to NCS-no.
972 according to RAL-no.
299 black
289 cashmere
236 crema-magnolia
222 crystal white
603 eucalyptus
338 graphite
504 greige
548 light grey
601 natural umber
285 pearl grey
231 taupe
235 velvet blue
291 white

high gloss lacquer (LH)
KP74/LI74

155 black
145 cashmere
543 crema-magnolia
298 crystal white
112 graphite
111 light grey
148 pearl grey
113 polar white
172 taupe
519 velvet blue
114 white

KP60/LI59
114 white

Light Rail

- Three different kinds of light rail
- Max length 360cm/142"
- Can be ordered to size or in standard length 360cm/142" to be cut on site
- Height not customizable



LI41, 46mm/1.8"

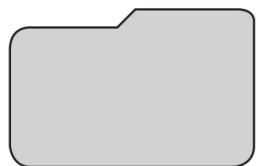

LI74, 32mm/1.6"



LI59, 45mm/1.8"

effect lacquer (LA) KP64/LI59

962 ash eff. according to NCS-no. 182 ash effect taupe
 973 ash effect according to RAL-no. 106 ash effect velvet blue
 071 ash effect agate blue 084 ash effect white
 079 ash effect black
 083 ash effect cashmere
 225 ash effect crema-magnolia
 048 ash effect crystal white
 607 ash effect eucalyptus
 040 ash effect graphite
 110 ash effect greige
 061 ash effect light grey
 606 ash effect natural umber
 105 ash effect pastel green
 094 ash effect pearl grey

satin lacquer (LM) KP74/LI74

961 according to NCS-no.
 972 according to RAL-no.
 299 black
 289 cashmere
 236 crema-magnolia
 222 crystal white
 603 eucalyptus
 603 eucalyptus
 338 graphite

504 greige
 548 light grey
 601 natural umber
 285 pearl grey
 288 polar white
 231 taupe
 235 velvet blue
 291 white

satin lacquer (LM) KP64/LI41

961 according to NCS-no.
 972 according to RAL-no.
 299 black
 289 cashmere
 236 crema-magnolia
 222 crystal white
 603 eucalyptus
 338 graphite
 504 greige
 548 light grey
 601 natural umber
 285 pearl grey
 231 taupe
 235 velvet blue
 291 white

high gloss lacquer (LH) KP74/LI74

155 black
 145 cashmere
 543 crema-magnolia
 298 crystal white
 112 graphite
 111 light grey
 148 pearl grey
 113 polar white
 172 taupe
 519 velvet blue
 114 white

KP60/LI59 114 white

Fillers

Häcker
kitchen.germanMade.



Version 10/2022

Box Filler

- Positioned flush with box
- only available in box colors
- Supplied in 10cm steps (3.9", 7.8", 11.7") and then trimmed on site
- UPK1078

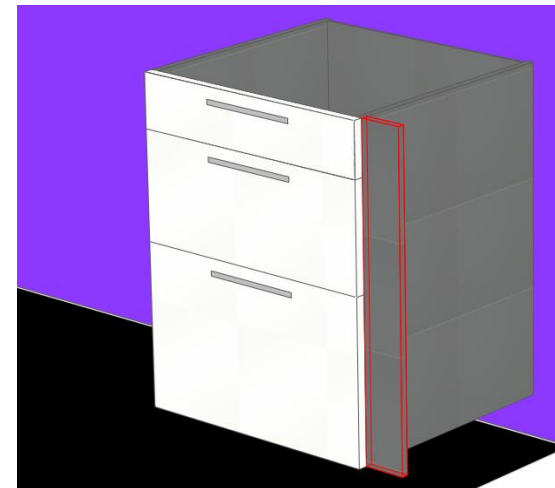
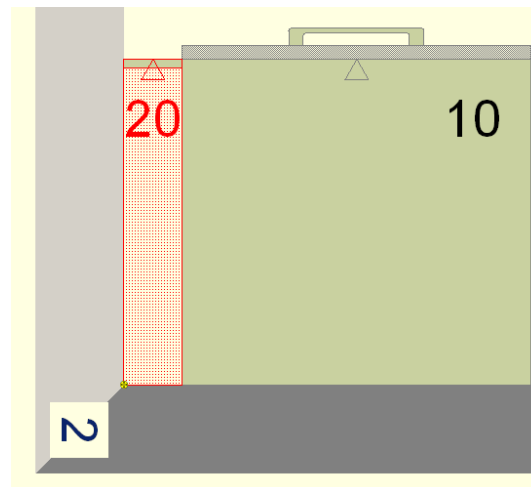

Front Filler

- Positioned flush with front
- available in all door styles and colors
- Can be compared to a filler overlay
- Supplied in 5cm (1 15/16") steps (max width 9 13/16") and then trimmed on site
- Glass, ceramic and stone veneer fillers cannot be trimmed on site, min. width is 50mm (1 15/16")
- Corner fillers only available as front fillers
- UPF578

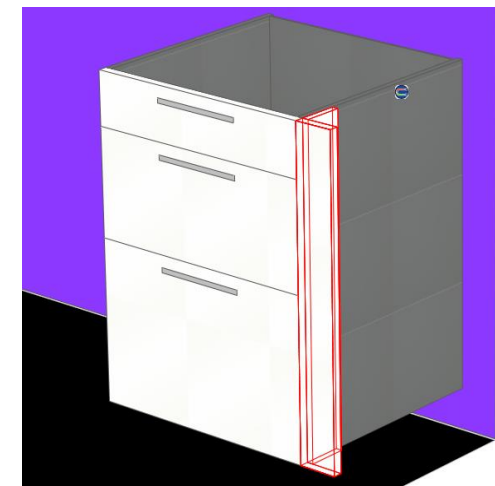
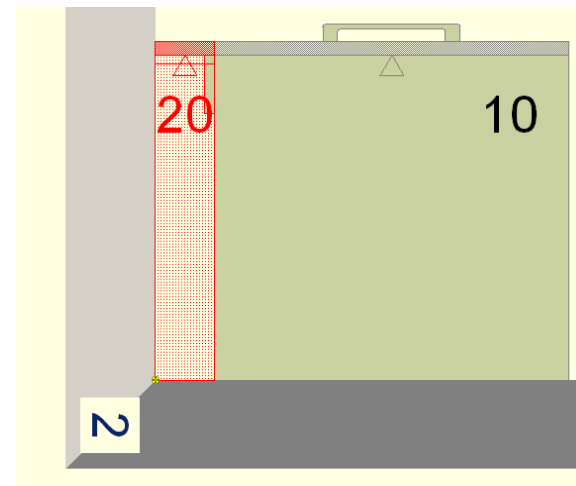

Panels

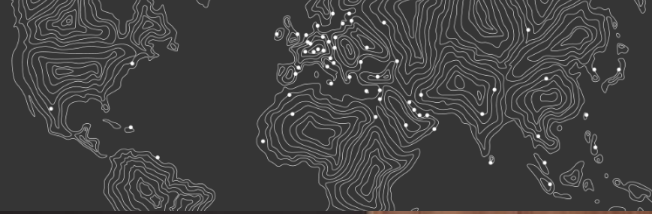

Häcker
kitchen.germanMade.



Version 10/2022



NV50 (vertical grain) / NV54 (horizontal grain)

- Generally used as backsplash
- All edges are finished
- Available in almost all front colors/finishes (except for AV5090/5095 glass, AV8000 ceramic and AV7030 stone)
- Also available in some countertop finishes
- Available in 16mm (5/8") thickness
- Also available in 25mm (1") as standard panel in max sizes

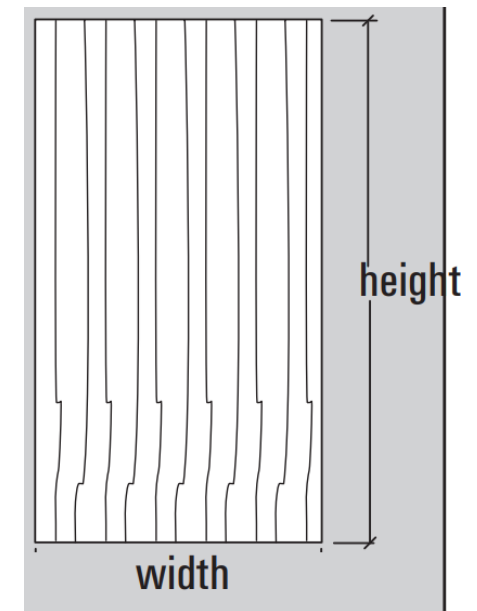
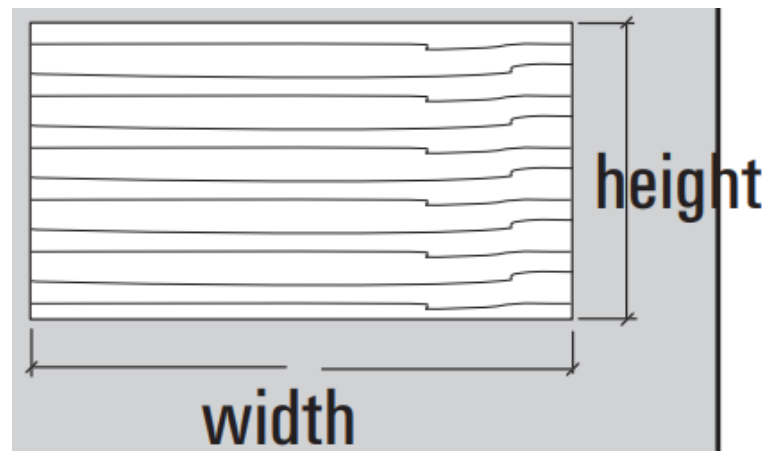

RW50 (vertical grain) / RW54 (horizontal grain)

- Generally used as back panel for island solutions
- All edges are finished
- Available in almost all front colors/finishes (except for AV5090/5095 glass, AV8000 ceramic and AV7030 stone)
- Also available in some countertop finishes
- Only available in 16mm (5/8") thickness
- Supplied with protective synthetic channel on the bottom

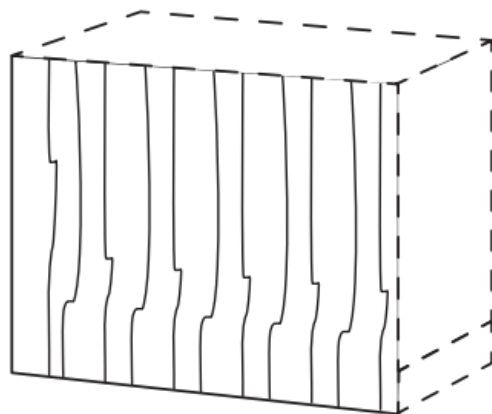

Version 10/2022

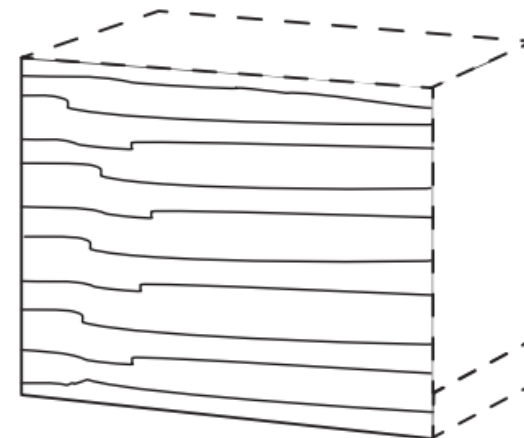

Side Panels (W.../WB...)

- W = box height excluding toe-kick
- WB = full height, comes with protective channel for bottom
- Four available thicknesses: 10mm (3/8", limited colors), 16mm (5/8"), 25mm (1"), 50mm (2", limited colors)
- All edges are finished
- Used when box or visible sides are not available in front color
- Also available in some countertop finishes
- Not available for AV5090/5095 glass, AV8000 ceramic and AV7030 stone veneer



Side Panels for AV5090/5095/8000/7030

- AV5090 (glossy glass): high gloss lacquer
- AV5095 (matt glass): matt lacquer
- AV8000: regular side panel in different color, stone side panels in front finish or Systemat ART front gable end made of front material
- AV7030: regular side panel in different color (mostly black because edges of front are black) or Systemat ART front gable end made of front material

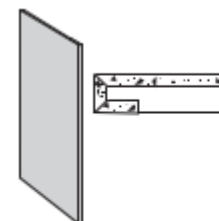

Stone side panel
1.6 cm, 2 cm, 2.5 cm thick
39 - 113 cm high
finished on one side
interior side finished on one
side by 100 mm
edges with mitered edge
cut

to be fitted on carcass side
always each full-height



1.6 cm and 2 cm only
Surface ceramic

NEW

Thickness	Depth	Price	Code
1.6 cm thick	up to 65 cm deep	1.6	GSE165113
	66-90 cm deep	1.6	GSE190113
	91-130 cm deep	1.6	GSE1120113
2 cm thick	up to 65 cm deep	2.0	GSE365113
	66-90 cm deep	2.0	GSE390113
	91-130 cm deep	2.0	GSE3120113
2.5 cm thick	up to 65 cm deep	2.5	GSE265113
	66-90 cm deep	2.5	GSE290113
	91-130 cm deep	2.5	GSE2120113

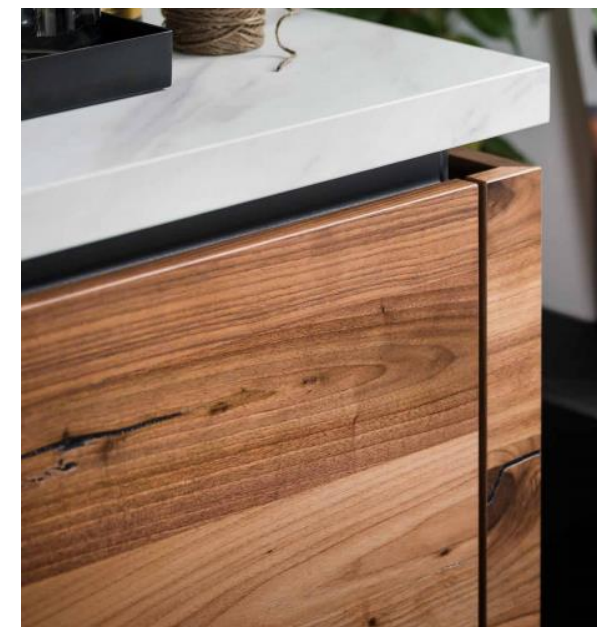

Panels (W.../WB.../NV50/NV54/RW50/RW54)

	mm					mm					mm					mm								
	10	16	25	50		10	16	25	50		10	16	25	50		10	16	25	50					
laminate (KU)					shiny laminate (KG)					satin lacquer (LM)					UV high gloss lacquer (LD)					PerfectSense®				
570 alpine oak effect	•	•	•	•	221 black	•	•	•	•	961 according to NCS-no.	•	•	•	•	247 cashmere	•	•	•	•	247 cashmere	•	•	•	•
364 arizona pine effect	•	•	•	•	345 cashmere	•	•	•	•	972 according to RAL-no.	•	•	•	•	197 crema-magnolia	•	•	•	•	197 crema-magnolia	•	•	•	•
568 basalt brown	•	•	•	•	269 crema-magnolia	•	•	•	•	299 black	•	•	•	•	183 crystal white	•	•	•	•	183 crystal white	•	•	•	•
239 black steel	•	•	•	•	294 crystal white	•	•	•	•	289 cashmere	•	•	•	•	127 graphite	•	•	•	•	127 graphite	•	•	•	•
188 black ultra matt	•	•	•	•	206 graphite	•	•	•	•	236 crema-magnolia	•	•	•	•	126 light grey	•	•	•	•	126 light grey	•	•	•	•
130 brushed steel	•	•	•	•	237 light grey	•	•	•	•	222 crystal white	•	•	•	•	200 pearl grey	•	•	•	•	200 pearl grey	•	•	•	•
340 cashmere	•	•	•	•	229 pearl grey	•	•	•	•	603 eucalyptus	•	•	•	•	179 polar white	•	•	•	•	179 polar white	•	•	•	•
329 cashmere ultra matt	•	•	•	•	209 polar white	•	•	•	•	338 graphite	•	•	•	•	195 taupe	•	•	•	•	195 taupe	•	•	•	•
228 cognac vintage oak effect	•	•	•	•	359 taupe	•	•	•	•	504 greige	•	•	•	•	186 white	•	•	•	•	186 white	•	•	•	•
219 crema-magnolia	•	•	•	•	202 white	•	•	•	•	548 light grey	•	•	•	•										
220 crema-magnolia ultra matt	•	•	•	•						601 natural umber	•	•	•	•										
077 crystal white	•	•	•	•	HPL (SC)					285 pearl grey	•	•	•	•	high gloss lacquer (LH)					high gloss lacquer (LH)				
265 crystal white ultra matt	•	•	•	•	563 crystal white	•	•	•	•	288 polar white	•	•	•	•	155 black	•	•	•	•	155 black	•	•	•	•
331 dark pine effect	•	•	•	•	166 polar white	•	•	•	•	231 taupe	•	•	•	•	145 cashmere	•	•	•	•	145 cashmere	•	•	•	•
376 graphite	•	•	•	•	187 taupe	•	•	•	•	235 velvet blue	•	•	•	•	543 crema-magnolia	•	•	•	•	543 crema-magnolia	•	•	•	•
322 graphite ultra matt	•	•	•	•	132 white	•	•	•	•	291 white	•	•	•	•	298 crystal white	•	•	•	•	298 crystal white	•	•	•	•
279 grey limestone	•	•	•	•										346 gold bronze-metallic	•	•	•	•	346 gold bronze-metallic	•	•	•	•	
049 grey oak grain-cut timber effect	•	•	•	•	effect lacquer (LA)					veneered brushed (FB)					112 graphite	•	•	•	•	112 graphite	•	•	•	•
337 grey pine effect	•	•	•	•	962 ash effect according to NCS-no.	•	•	•	•	428 black oak	•	•	•	•	111 light grey	•	•	•	•	111 light grey	•	•	•	•
022 light grey	•	•	•	•	973 ash effect according to RAL-no.	•	•	•	•	433 elegant oak	•	•	•	•	148 pearl grey	•	•	•	•	148 pearl grey	•	•	•	•
123 light grey ultra matt	•	•	•	•	071 ash effect agate blue	•	•	•	•	472 larch	•	•	•	•	113 polar white	•	•	•	•	113 polar white	•	•	•	•
272 light moon stone	•	•	•	•	079 ash effect black	•	•	•	•	466 mocha vintage oak	•	•	•	•	172 taupe	•	•	•	•	172 taupe	•	•	•	•
325 light pine effect	•	•	•	•	083 ash effect cashmere	•	•	•	•	470 natural wild oak	•	•	•	•	114 white	•	•	•	•	114 white	•	•	•	•
258 light summer oak effect	•	•	•	•	225 ash effect crema-magnolia	•	•	•	•	471 nougat wild oak	•	•	•	•										
567 marble anthracite	•	•	•	•	048 ash effect crystal white	•	•	•	•	465 sherry vintage oak	•	•	•	•										
018 mountain oak effect	•	•	•	•	607 ash effect eucalyptus	•	•	•	•	473 walnut	•	•	•	•										
027 natural butcherblock effect	•	•	•	•	040 ash effect graphite	•	•	•	•	434 elegant walnut	•	•	•	•										
026 natural oak grain-cut timber effect	•	•	•	•	110 ash effect greige	•	•	•	•															
233 natural vintage oak effect	•	•	•	•	061 ash effect light grey	•	•	•	•	veneered embossed (FP)														
181 ontario oak effect	•	•	•	•	606 ash effect natural umber	•	•	•	•	409 reclaimed wood	•	•	•	•	• = available									
243 oxide	•	•	•	•	105 ash effect pastel green	•	•	•	•	408 smoked oak	•	•	•	•										
078 pearl grey	•	•	•	•	094 ash effect pearl grey	•	•	•	•	407 volcano oak	•	•	•	•										
330 pearl grey ultra matt	•	•	•	•	182 ash effect taupe	•	•	•	•															
052 polar white	•	•	•	•	106 ash effect velvet blue	•	•	•	•	lacquer shiny metallic (FP)														
388 polar white ultra matt	•	•	•	•	084 ash effect white	•	•	•	•	324 industrial steel	•	•	•	•										
292 putty concrete black	•	•	•	•						(max 240 x 80 cm)														
381 putty concrete graphite	•	•	•	•	UV satin lacquer (LMD)																			
314 putty concrete opal grey	•	•	•	•	PerfectSense®																			
312 putty concrete pearl grey	•	•	•	•	512 black	•	•	•	•															
023 rustic butcherblock effect	•	•	•	•	588 black fine oak effect	•	•	•	•															
008 silk grey oak effect	•	•	•	•	578 black velvet oak effect	•	•	•	•															
024 stainless steel col.	•	•	•	•	533 carrara white	•	•	•	•															
189 summer oak effect	•	•	•	•	577 cashmere	•	•	•	•															
246 summer oak silver-grey eff.	•	•	•	•	537 crema-magnolia	•	•	•	•															
176 taupe	•	•	•	•	507 crystal white	•	•	•	•															
363 taupe ultra matt	•	•	•	•	587 dark walnut effect	•	•	•	•															
321 terra	•	•	•	•	511 graphite	•	•	•	•															
205 vintage oak effect	•	•	•	•	576 graphite velvet oak effect	•	•	•	•															
058 walnut effect	•	•	•	•	566 greige velvet oak effect	•	•	•	•															
038 white	•	•	•	•	564 grey marble	•	•	•	•															
310 white ultra matt	•	•	•	•	579 light fine oak effect	•	•	•	•															
					565 light grey	•	•	•	•															
stainless steel (ED)					144 marble dark	•	•	•	•															
190 stainless steel effect	•	•	•	•	585 natural fine oak effect	•	•	•	•															
					586 natural walnut effect	•	•	•	•															
					510 pearl grey	•	•	•	•															
					500 polar white	•	•	•	•															
					509 taupe	•	•	•	•															
					508 white	•	•	•	•															

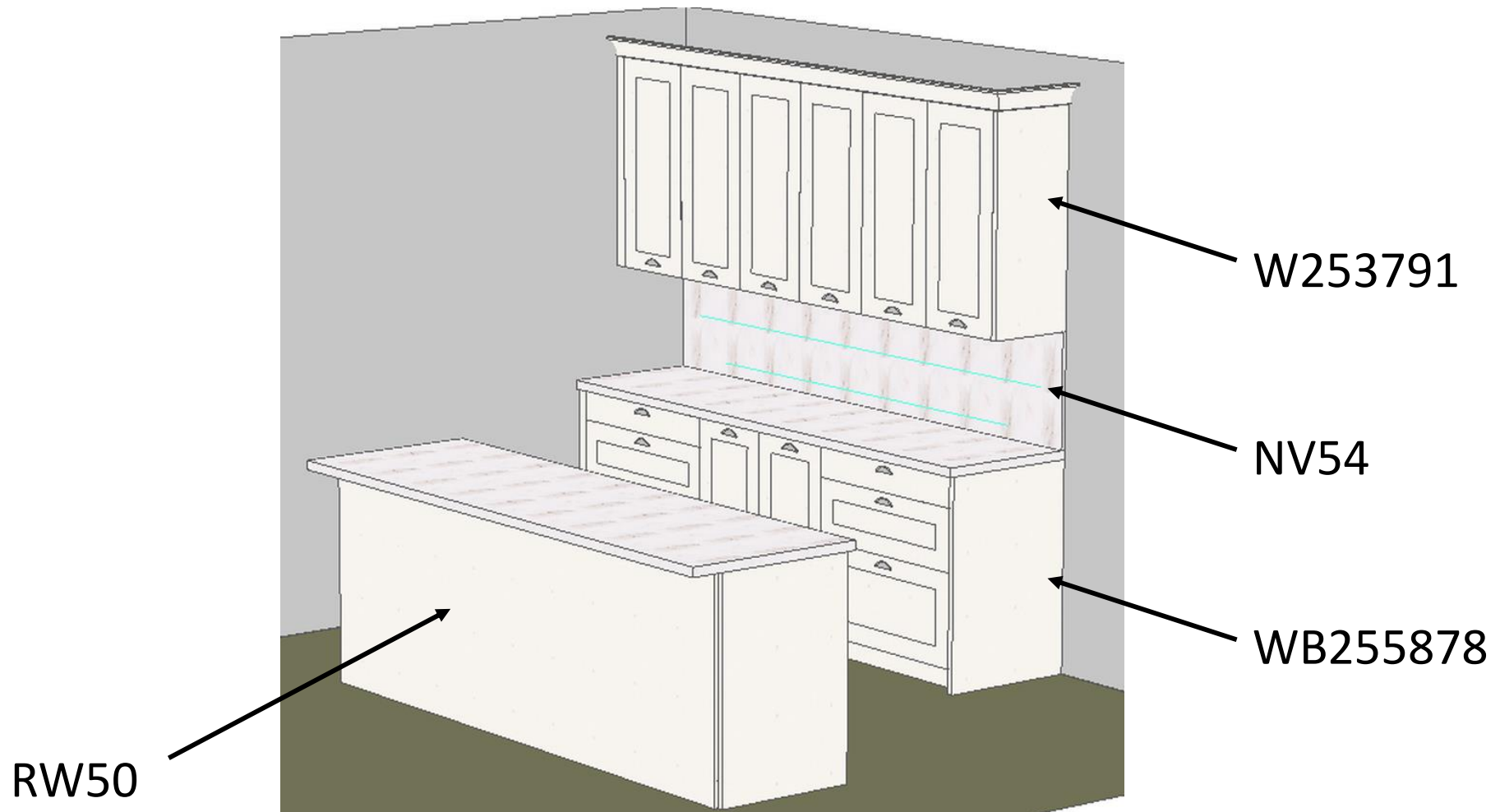

Open discussion & questions



Thank you for your attention

